

Article number: 12318000100160
Description: KLEE-coil 318 000 100.160
M10 Hardened/zinc-plated slotted pin

Measures

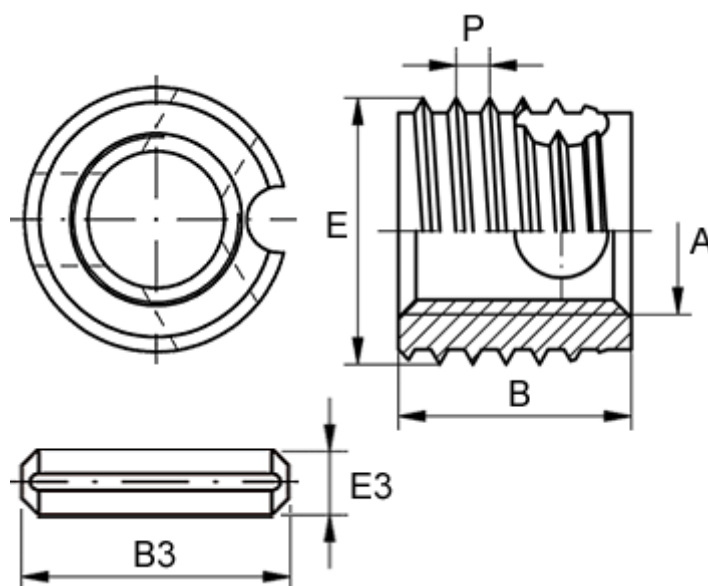

Female thread A	= M10
Length B	= 18
Male thread E	= 14.0
Min hole depth blind hole	= 22
Slotted pin B3	= 16
Slotted pin E3	= 2
Thread pitch P	= 1.50
Type	= 318 000 100 ...